

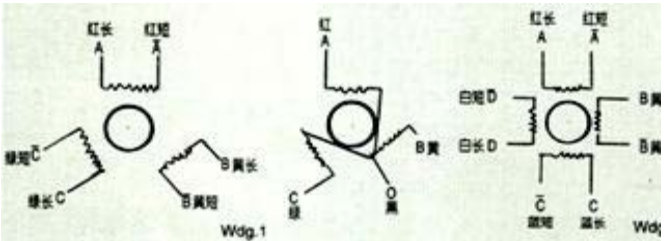

磁阻式步进电机 28BF 36BF 45BF 55BF

接线图1



技术数据:

型号	相数	步距角	电压	电流	保持转矩	空载启动频率	运行频率	接线图	备注
Model	No.of Phase	Step Angle (Deg.)	Voltage (V)	Current(A)	Holding Torque Nm(kg.cm)	No-load pull-in Frequency(Hz)	Pull-out Frequency(Hz)	Wdg	Notes
28BF001	3	3/6	27	0.8	0.017(0.18)	180 0		1	
36BF003-2	3	3/6	27	0.6	0.049(0.5)	190 0		1	
36BF003	3	1.5/3	27	1.5	0.078(0.8)	310 0		1	
45BF003-2	3	1.5/3	60	2	0.196(2)	370 0	12000	1	
45BF005-2	3	1.5/3	27	2.5	0.196(2)	3000		1	
45BF005-3	3	1.5/3	27	2.5	0.098(1)	290 0		1	
45BF008	3	1.5/3	24	0.2	0.118(1.2)	50 0		1	
45BC340C	3	1.5/3	12	0.4	0.118(1.2)	50 0		1	
55BF001	3	7.5/15	27	2.5	0.372(3.8)	75 0		1	
55BF003	3	1.5/3	27	3	0.666(7)	1800		1	
55BF004	3	1.5/3	2	3	0.49(5)	2200		1	
55BF004-2	3	1.5/3	30	0.5	0.49(5)	550		1	
55BF009	4	0.9/1.8	27	3	0.784(8)	2500		2	

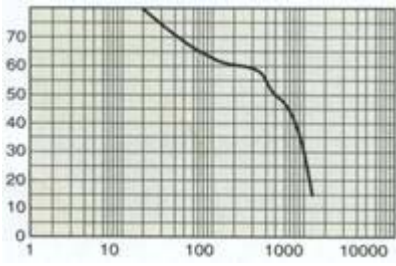

PULSE RATE(Hz)
28BF001

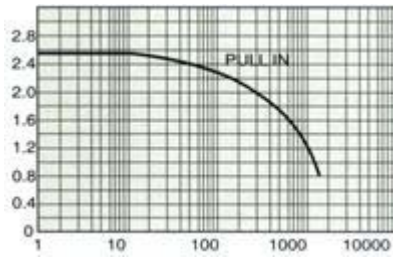

PULSE RATE(Hz)
36BF002-2

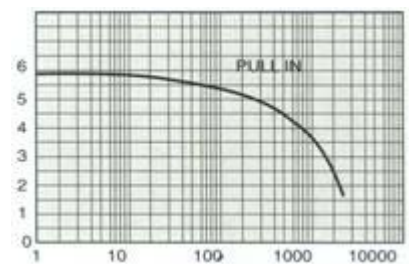

PULSE RATE(Hz)
36BF003

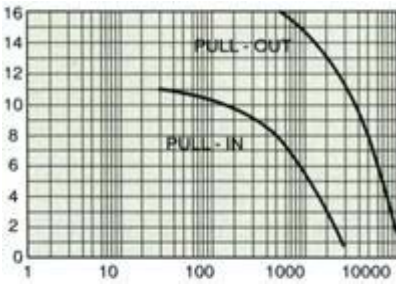

PULSE RATE(Hz)
45BF003-1

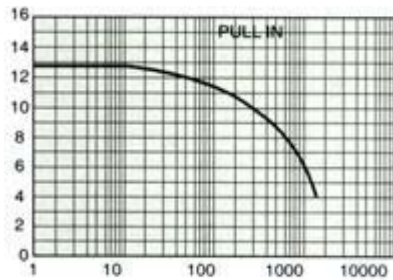

PULSE RATE(Hz)
45BF005-2

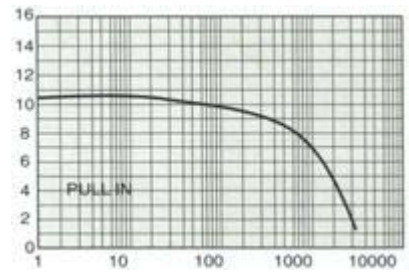

PULSE RATE(Hz)
45BF005-3

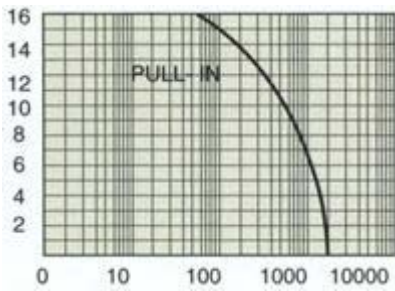

PULSE RATE(Hz)
45BF006

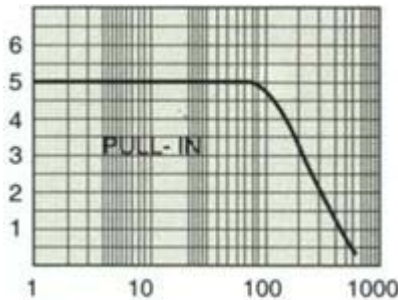

PULSE RATE(Hz)
55BF001

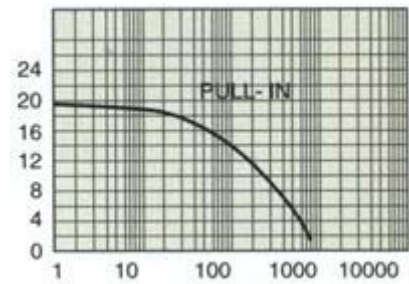

PULSE RATE(Hz)
45BF340C 45BF008

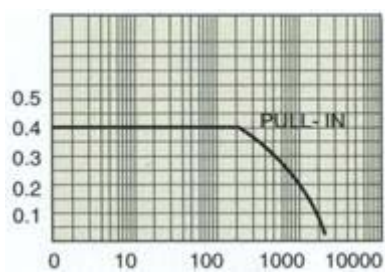

PULSE RATE(Hz)

55BF003

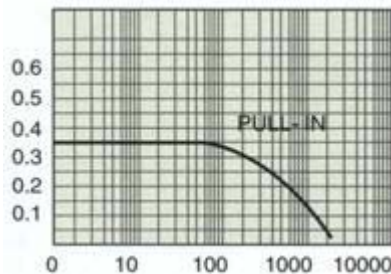

PULSE RATE(Hz)

55BF004

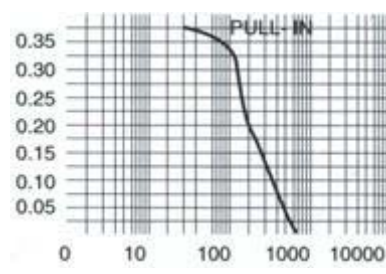

PULSE RATE(Hz)

55BF004-2

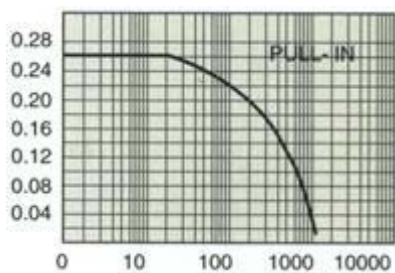

PULSE RATE(Hz)

55BF005

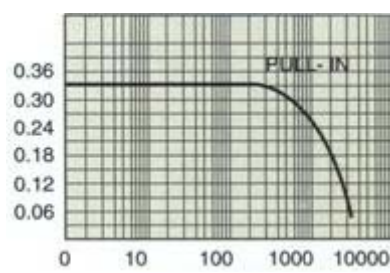

PULSE RATE(Hz)

55BF009

外形图

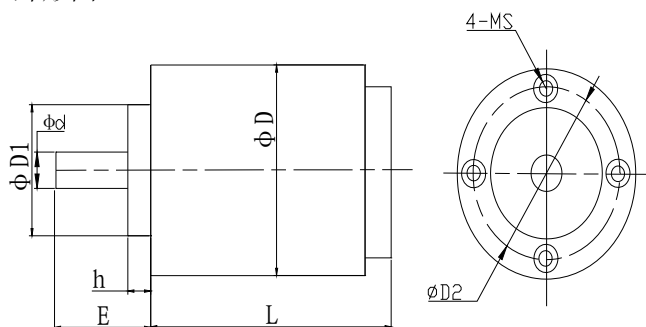

地址：江苏省常州市戚墅堰区芳渚村360号
 电话:0519-88352577 88359735 传真:0519-8352858

www.czshuangjie.com